

PANELLUX® METAL CEILING SNAP IN







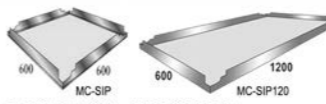

ARKADIA TOWER G, PASAR MINGGU - JAKARTA

PANELLUX® METAL CEILING SNAP IN

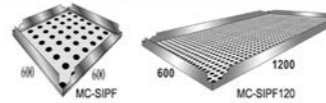
PANELLUX® Metal Ceiling Snap In is easy to install and provides a functional look towards your ceiling profile. With profile width of either 60x60cm and 60x120cm, it will give an elegant minimalistic look. It is ideally applied in both interior and exterior ceiling projects, including terraces, corridors, canopies and lobbies in airport terminals, shopping malls, showrooms, apartments, offices, factories and other types of projects.

PANELLUX® Metal Ceiling Snap In is made of Pre-painted Aluminium Alloy 100. Installation is easy with stringer suspension with Clip-Lock system without the need of bolts nor fasteners.

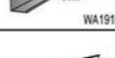
PRODUCT	INFORMATION	PRODUCT	INFORMATION
 ROD M5	Material : Wire Rod Galvanized 5mm	 MC-SIP 600 MC-SIP 1200	METAL CEILING - SNAP IN PLAIN 60x60 & 60x120 Material : Aluminium Standard Color : White, Silver Thickness : 0,6mm
 U CLAMP K4-TBC	Material : Galvanized Steel	 MC-SIPF 600 MC-SIPF 1200	METAL CEILING - SNAP IN PLAIN 60x60 & 60x120 Material : Aluminium Standard Color : White, Silver Thickness : 0,6mm Perforation : Ø 2,3mm
 C-CHANNEL RG-1	Material : Zincalume® Steel		
 CHANNEL CLAMP SNAP BAR K-10S	Material : Zincalume® Steel		
 SNAP BAR SBB	Material : Galvanized Steel Length : 3000mm		
 WALL ANGLE WA1919	Material : Aluminium Length : 3000mm		
 SHADOW MouldING SM1914	Material : Aluminium Length : 3000mm		

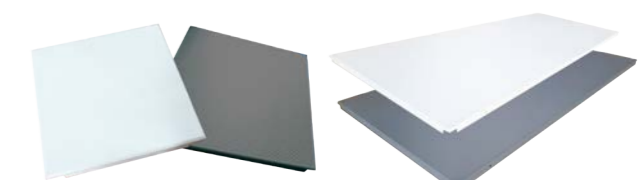
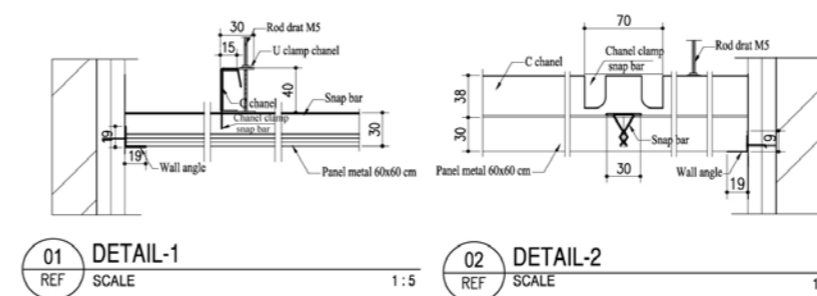
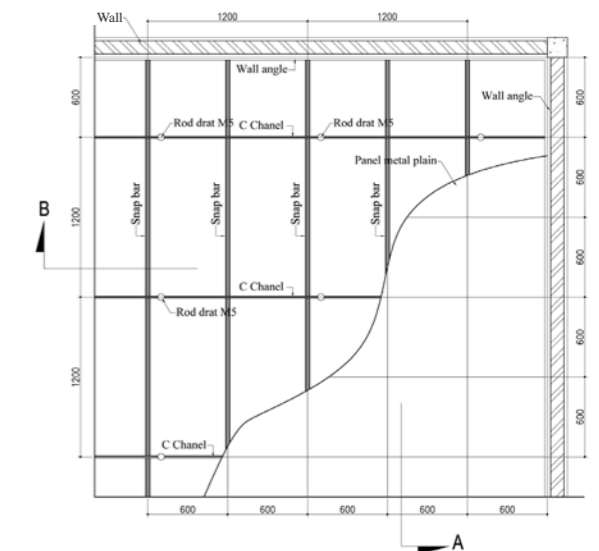
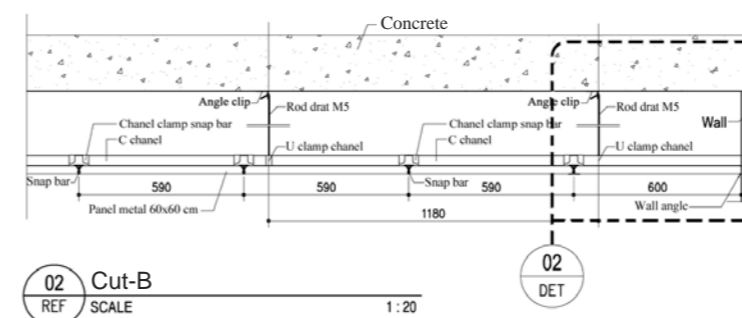
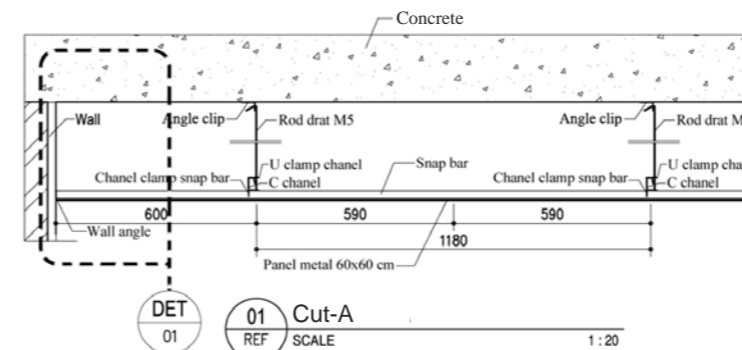
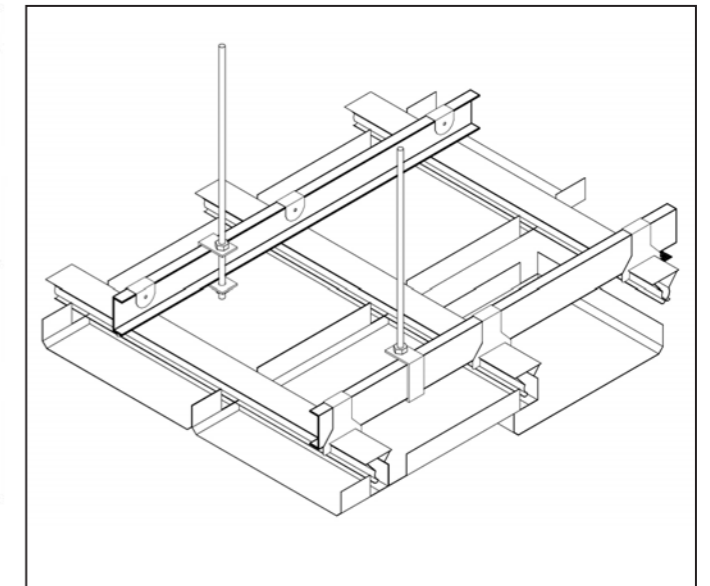

60 x 60

60 x 120

METAL CEILING SNAP IN